

Application note: BSW-20 for super-resolution imaging



Table of Contents

1	Introduction	3
1.1	Working principle	4
1.2	Beam shift as a means to increase resolution	4
2	Application example: Imaging with super-resolution	6
2.1	Setup.....	6
2.2	Results	8
3	Application example: Display inspection	9
4	Further information and support.....	9

1 Introduction

The resolution of any imaging system is ultimately limited by the size of its pixels. A commonly used method to overcome the resolution limitation, sometimes referred to as super-resolution, is to use pixel shift. Pixel shift methods are available in certain camera models, where the image sensor is moved one pixel at a time in between sequentially taken images. By combining images, a single image with sub-pixel resolution can be generated, owing to the fact that each individual pixel in the combined image carries the necessary color and brightness information.

Instead of physically moving the sensor, Optotune's beam shifter displaces the light impinging on the sensor. This is done by accurately tilting a glass window, laterally translating the incoming beam and yielding lower noise and super-resolution imaging beyond the pixel limit. The beam shifter BSW-20 has a large clear aperture of 20 x 20 mm², suitable for a wide range of imaging and projection applications. It can be used for debayering, avoiding interpolation on color cameras, and display inspection, but also in non-imaging applications such as optical fiber-coupling, 3D printing and metrology. The BSW-20 can furthermore be advantageous in applications where smaller pixels or larger sensors are unavailable or too expensive.

Main features:

- Fast transition times (~1 ms)
- Highly reliable and suitable for continuous operation
- High angular position accuracy (typically ±5%)
- Bearingless design – no particles generated, no wear, no friction
- Beam shifts of up to 4.8 µm supported

For more technical specifications, please see the [datasheet](#). For instructions on setting up and running the device, see the [manual](#). Optotune offers a development kit for the BSW-20 that includes the four-channel controller [ICC-4C-2000](#) ([datasheet](#)).

1.1 Working principle

The BSW-20 works by laterally shifting an incoming beam. The shift is performed by tilting a planar glass window through which the impinging beam is passing. The relation between the tilt angle θ and resulting beam displacement Δy is shown in Fig. 1. Here, t denotes the thickness of the glass window and n its refractive index.

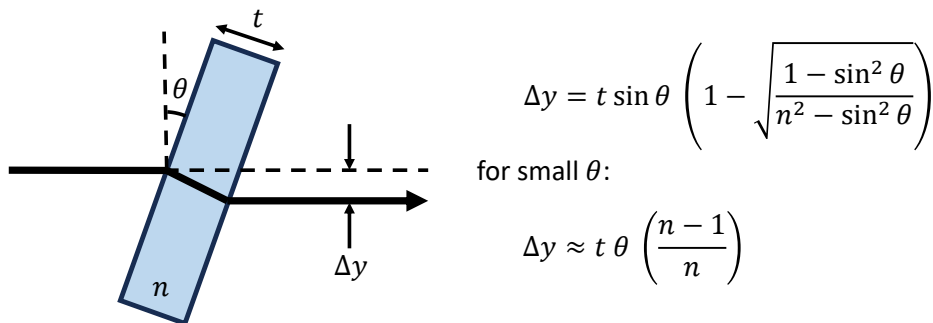

Figure 1: The BSW-20 actuator principle. Tilting a glass window an angle θ results in a lateral beam shift Δy . For small angles, the expression for Δy can be simplified.

1.2 Beam shift as a means to increase resolution

The BSW-20 can tilt a glass window along two axes to reach four distinct positions – so-called 4-position (4P) beam shifting. The principle is illustrated in Fig. 2. As a result, each pixel is projected at four locations, quadrupling the resolution (increasing the resolution by up to a factor of two in each lateral direction). Note that even with beam shifting, the resolution will ultimately be limited by the diffraction limit.

The driving pattern can be of arbitrary shape, not limited to a square, and patterns with fewer and more positions are possible.

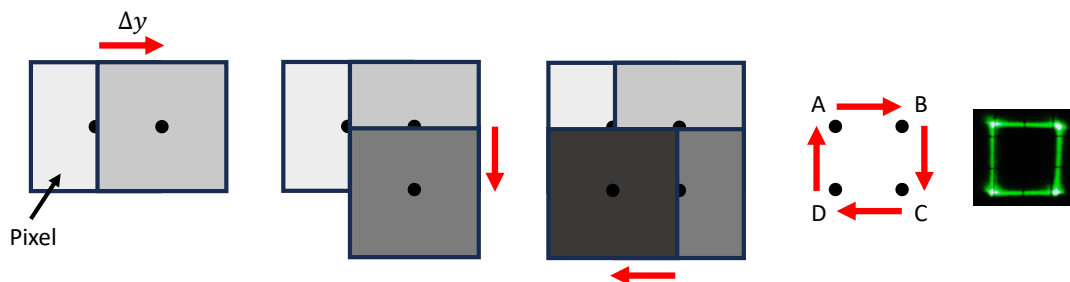

Figure 2: 4-position (4P) beam shifting. Each pixel is projected at four locations A, B, C and D, resulting in an up to four-fold increase in the native resolution. The rightmost image shows the effect on a reflected laser beam, with the four corners of the square corresponding to the four positions of the BSW-20.

In color imaging, an image is often created using a Bayer color filter array. In such an array, each pixel is filtered to record only one of three colors. A full-color image is obtained after debayering, or demosaicing, in which a set of red, green and blue values is interpolated for each pixel. The simplest approach is to average the values of the nearest neighbors of each pixel. The approach works well in

areas with smooth color gradients or constant color, but causes artifacts in the resulting image along the edges, for small-scale details, and in areas with abrupt color changes.

Beam shift is a direct way to overcome this problem and avoid artifacts in color images. Figure 3 illustrates how, by performing three beam shifts with the BSW-20, each pixel ends up carrying the complete color information. In this way, the digital image can be reconstructed by processing the information from four consecutive images, without artifacts related to interpolation.

Bayer color filter array



Without beam shift:

Channel separation

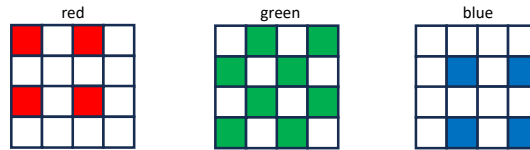

Interpolation

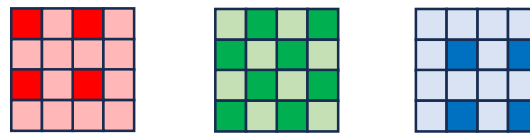

With beam shift:

Shift beam 1 pixel width to the right

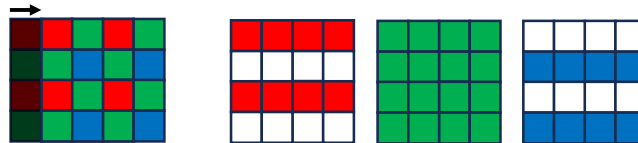

Shift beam 1 pixel width down

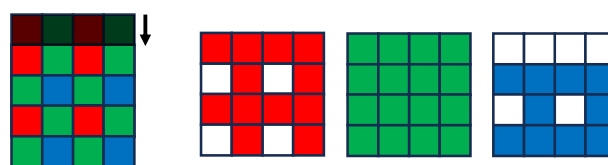

Shift beam 1 pixel width to the left

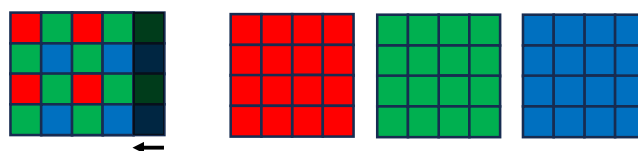

Figure 3: Color imaging. Without beam shift (top), the final image relies on interpolation of each color channel. With beam shift (bottom), each pixel contains the complete color data, and the final image is obtained without relying on interpolation.

2 Application example: Imaging with super-resolution

2.1 Setup

In order to visualize the resolution improvements produced with the BSW-20, the setup shown in Fig. 4 can be used. The BSW-20 is controlled using Optotune's ICC-4C-2000 controller; a development kit containing the BSW-20, ICC-4C-2000, adapter board, and necessary cables is available by request.

To prevent stray light from affecting the measurement, a custom 3D-printed mount is used for fixing the BSW-20 between the camera and the objective. Detailed CAD drawings of this solution (see Fig. 5 and 6) can be obtained by request. The objective lens is a 35 mm focal length lens (Kowa LM35HC-OPT, C-mount, 31.5 x 61.5 mm, recommended pixel size 5.0 μm). A back-illuminated 1951 USAF Resolution Test Target is used to illustrate the change in resolution.

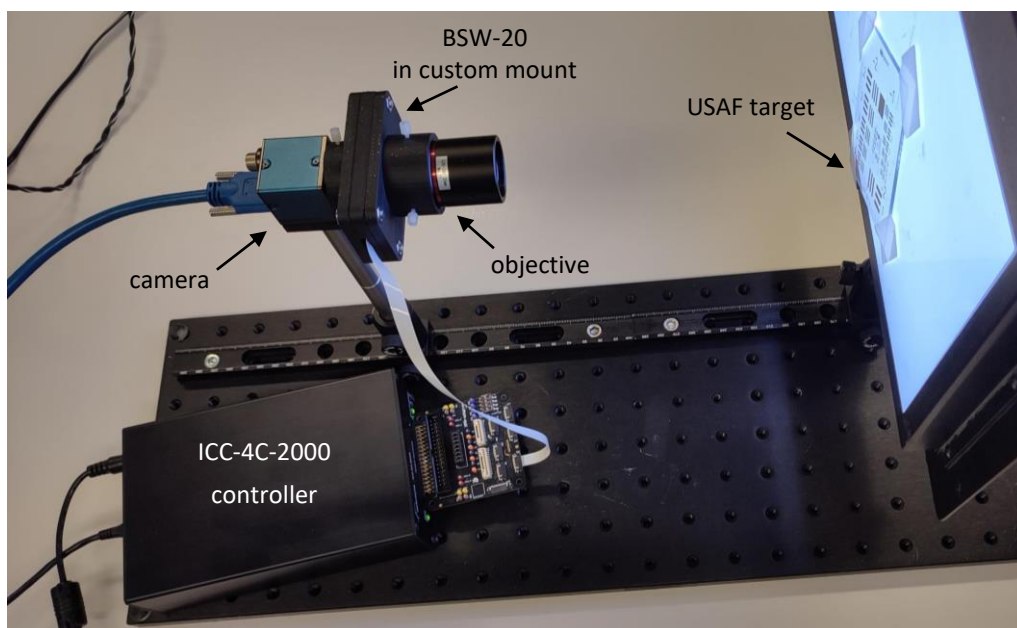

Figure 4: Setup assembly with the BSW-20 placed between the camera and the objective. A USAF target is used to visualize the change in resolution.

The collective assembly of the camera, BSW-20 and objective using the custom mount is shown in Fig. 5. The three 3D-printed parts are illustrated in Fig. 6. Design files can be obtained upon request.

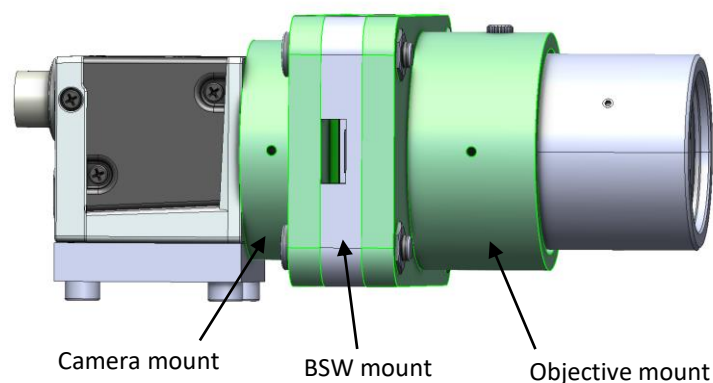
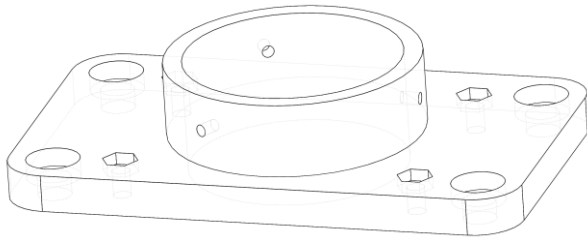
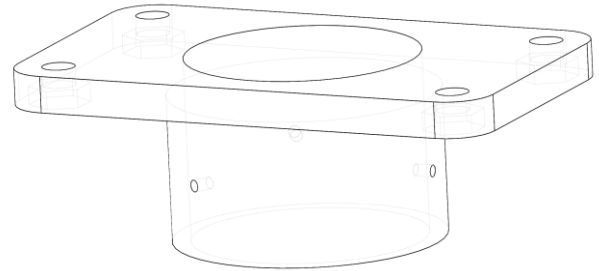

Figure 5: CAD model of the assembly with the camera, BSW-20 and objective.

Camera mount



Objective mount



BSW mount

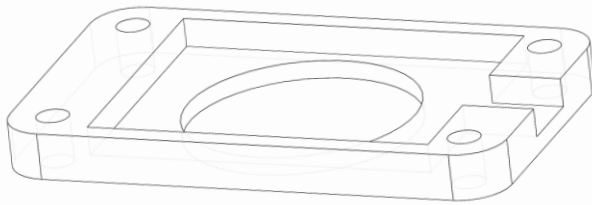

Figure 6: Custom parts used for mounting the camera, BSW-20, and the objective together. Detailed design files are provided by request.

An important design consideration when implementing the BSW-20 in an imaging application is that the incorporation of the beam shifter will increase the effective back focal length of the lens closest to the sensor. This increase is due to the beam shift imposed by the BSW-20 for rays impinging at an angle. Figure 7 shows that a sensor positioned at the back focal length f of a lens will need to be shifted back a distance Δf to accommodate for the BSW-20 and the associated beam shift for off-axis rays. For the BSW-20 with its 2 mm thick B270 (crown glass) window, the increase in the back focal length corresponds to 0.7 mm.

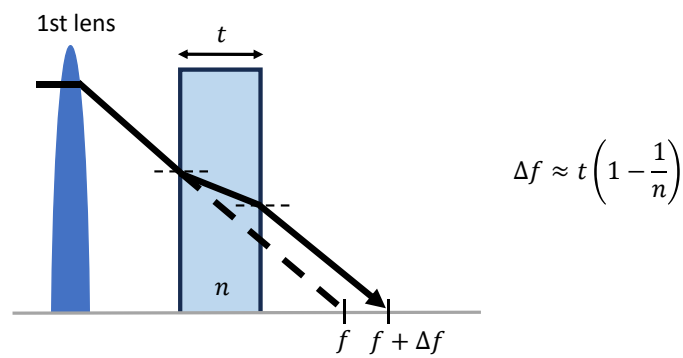

Figure 7: Increase in the back focal length upon inserting a transparent window into the beam path. The back focal length increases by a factor given by the thickness t and refractive index n of the glass.

2.2 Results

Imaging the USAF target on a monochromatic camera with and without turning on the BSW-20 results in the two images shown in Fig. 8. Here, the lateral resolution is increased by 41%, from 198 lp/mm (USAF group 4, element 4) to 280 lp/mm (USAF group 5, element 1) when using the beam shifter – far beyond the Nyquist limit of 208 lp/mm for the camera used.

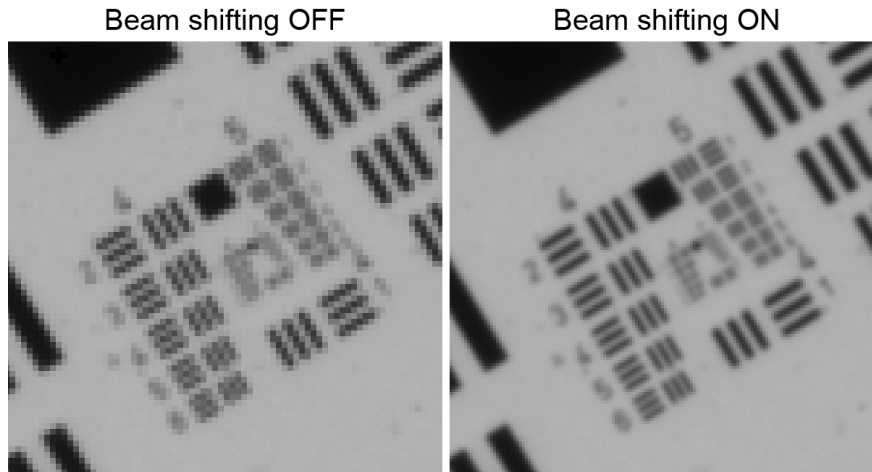

Figure 8: (Left) USAF target imaged on a monochromatic camera with the BSW-20 turned off. (Right) USAF target imaged with the BSW-20 turned on. The lateral resolution improves by 41%.

Another example can be made using the red channel of a color camera. The result is shown in Fig. 9. Here, the lateral resolution is increased by 100%, from 65 lp/mm (USAF group 3, element 4) to 130 lp/mm (USAF group 4, element 4) – approaching the Nyquist limit of 145 lp/mm for the camera used. This allows for achieving full resolution on all three color channels.

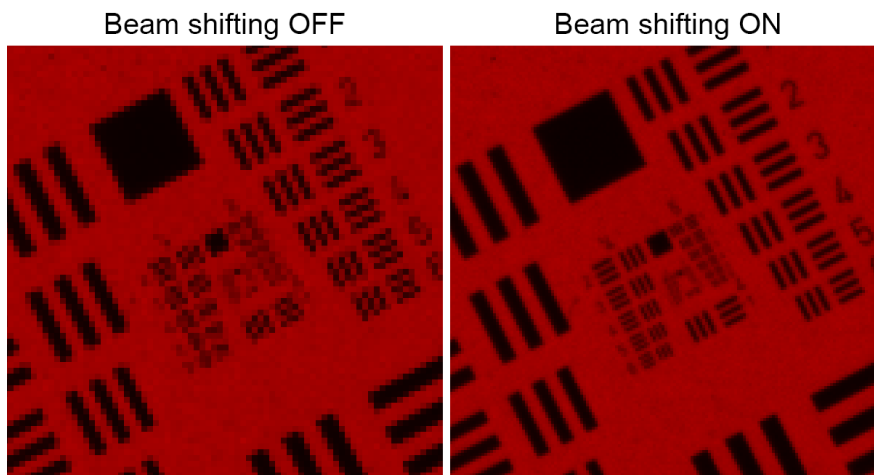

Figure 9: (Left) USAF target imaged on the red channel of a color camera with the BSW-20 turned off. (Right) USAF target imaged with the BSW-20 turned on. The lateral resolution improves by 100%.

3 Application example: Display inspection

The measurement described in the previous section can be used for high-resolution inspection. Here, we apply the method to inspect a phone display, see Fig. 10. The increase in resolution provided by the BSW-20 allows for more precise identification of defects such as missing pixels.

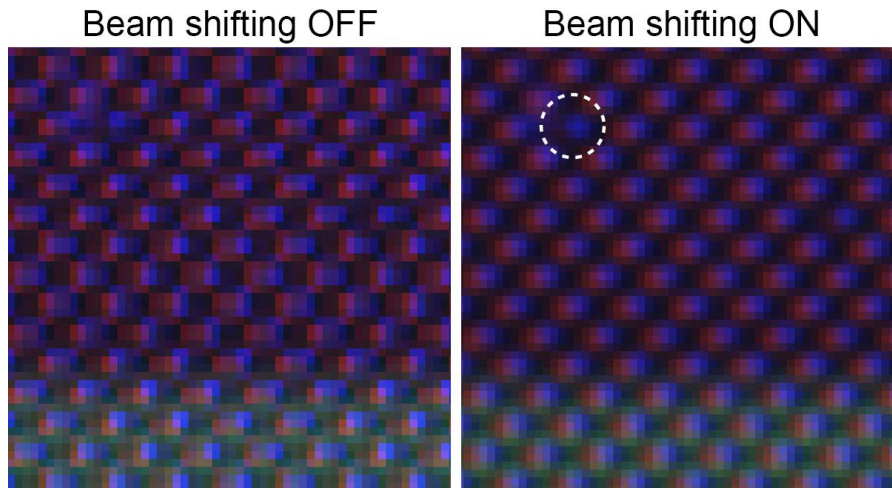

Figure 10: (Left) Phone display imaged with the BSW-20 turned off. (Right) Phone display imaged with the BSW-20 turned on. Missing pixels (identified by the white dashed circle) can easily be identified.

4 Further information and support

We are happy to advise you about the integration of the BSW-20 into your design. Do not hesitate to contact us at sales@optotune.com.