

shaping the future of optics

CONFIDENTIAL

Optotune

Laser speckle reducers

Zurich, September 2022

Dr. David Leuenberger, Senior Business Development Manager

Bernstrasse 388 | CH-8953 Dietikon | Switzerland
Phone +41 58 856 30 86 | www.optotune.com | info@optotune.com

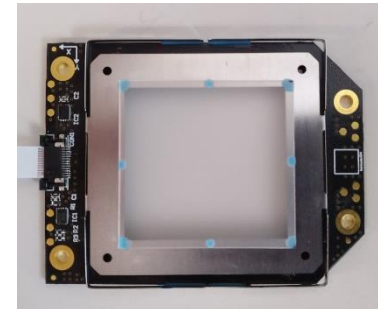
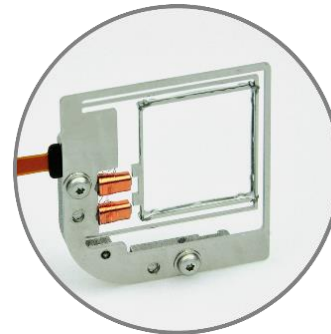

Agenda



- Intro
- Products
- Applications

Speckle reduction principle: A moving diffuser is used to increase angular diversity



Principle

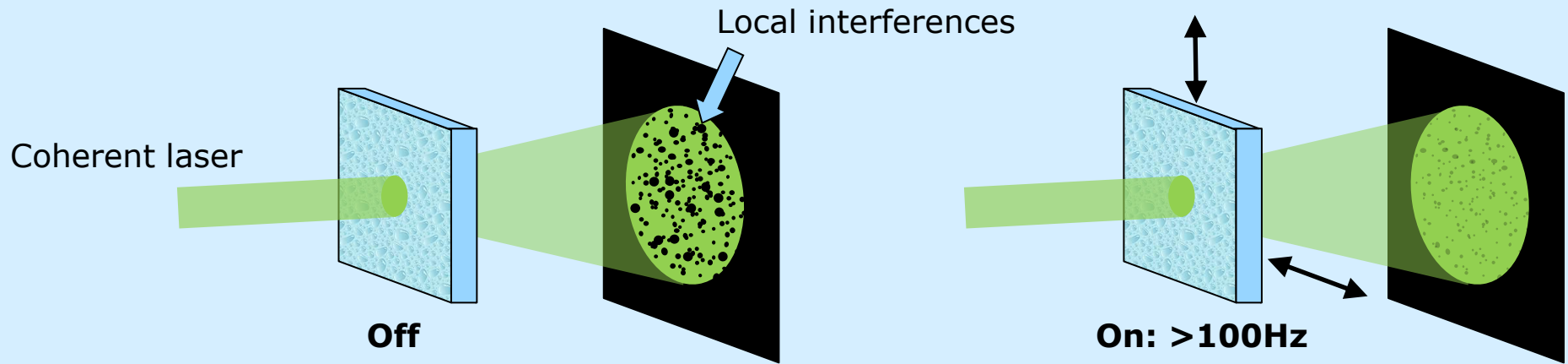

By moving a diffuser multiple speckle patterns are overlapped to reduce the perceived speckle noise

Agenda



- Intro
- Products
- Applications

De-speckling products



Reluctance force-based LSR

In production



Voice coil based LSR

Prototype

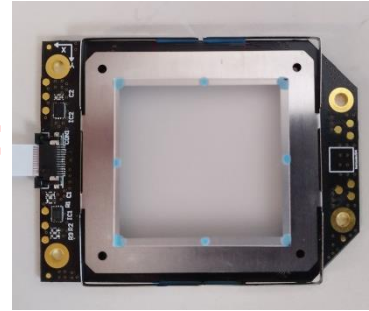

Name	LSR-4C	LSR-30
Aperture	18.5x18.5 mm	30x30 mm
Diffuser type	Glass or polycarbonate	Glass or Polycarbonate
Transmission	>98%	>98%
Oscillation type	1D (linear)	2D
Oscillation amplitude	±800 um	1mm (radius)
Resonant frequency	~120 Hz (depends on diffuser weight)	~50 Hz
Operating lifetime	>40'000	Designed for long lifetime
Electronics	5 VDC (coils are pulsed with current)	PWM current driver

LSR-4C options

- 3 diffuser types available from Optotune
 - VIS-coated fused silica: 8.5°
 - Uncoated fused silica: 8.5°
 - Uncoated polycarbonate diffusers: 1, 5, 10, 20°
- Brass bracket available for prototyping
- USB power supply

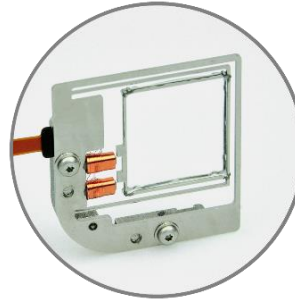

LSR-4C-L

- Single diffuser configuration:

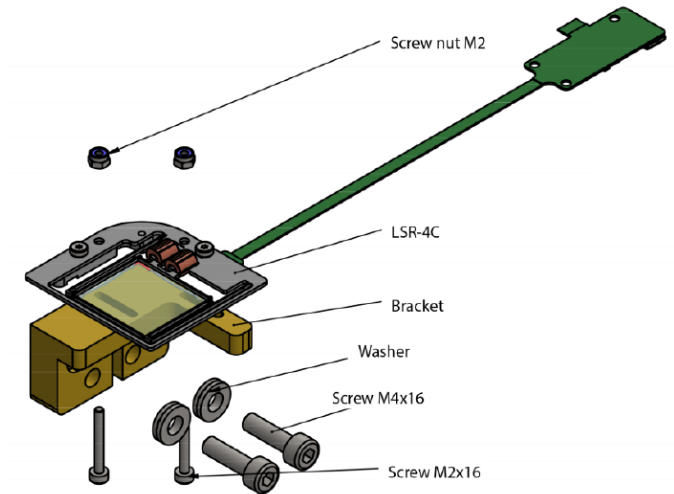

- Double configuration

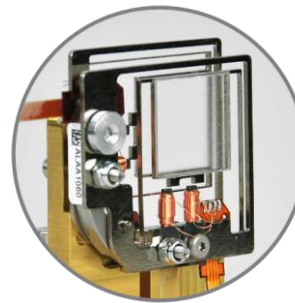

LSR-4C-LL

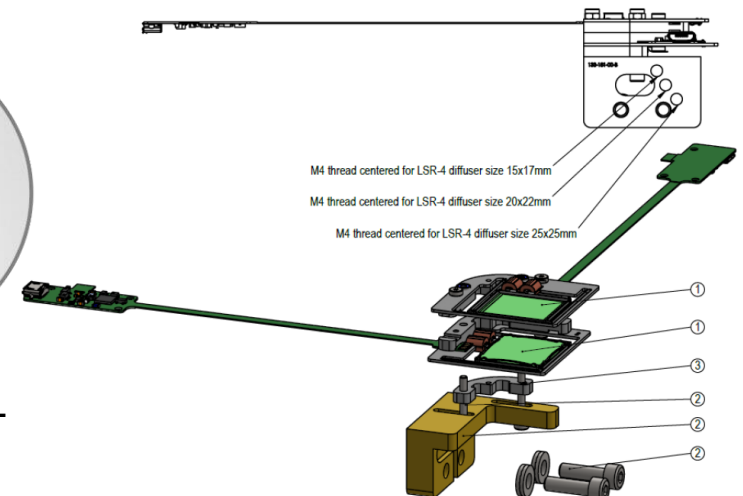

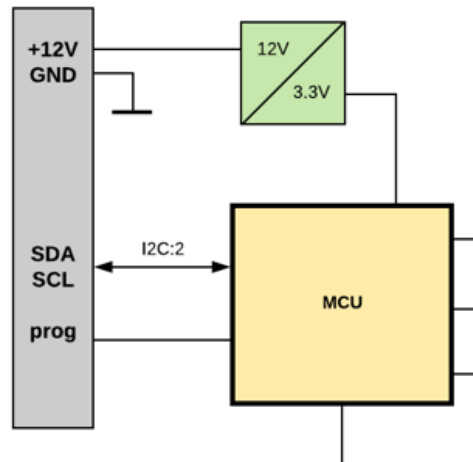
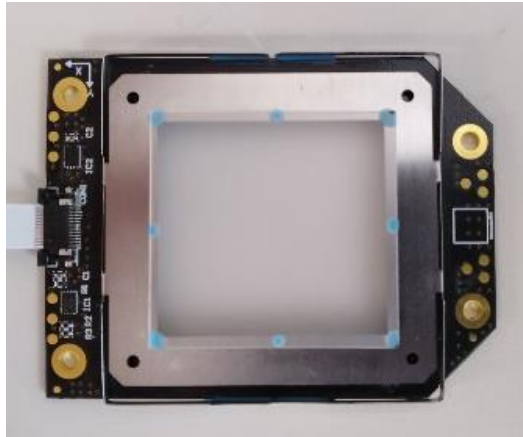
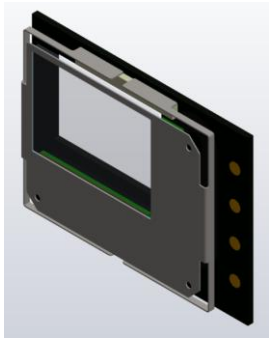

New LSR platform concept



- 2D movement
- Clear aperture from few mm to > 60x60 mm²
- Up to 2mm movement radius
- Integrated design
- Leverage XPR platform (proven design for high-volume manufacturing)
- Can be customized to different apertures (customization project)
- Various operating modes possible
- System integration possibilities
 1. Optotune provides actuator only
 2. Optotune provides actuator with simple calibrated electronics on board (12V power supply, I2C interface)

New 2D LSR vs spinning disk diffuser

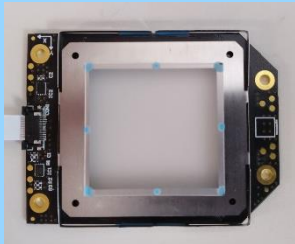

	New 2D LSR	Spinning disk diffuser
		
Fill factor (CA vs size)	50-60%	<35%
Non-isotropic diffusers (e.g. elliptical)	Possible	Not possible
Constant speed over aperture	Yes	No
Movement	True 2D	1D (rotation)
Integration	Only 4mm thick, actuator integrated	Requires a lot of space for motor
Reliability/lifetime (e.g. shock & vibration)	Solid-state, no bearings	Bearings could degrade under shock & vibration

Optotune offers LSR-30 devkit to validate the technology in the application

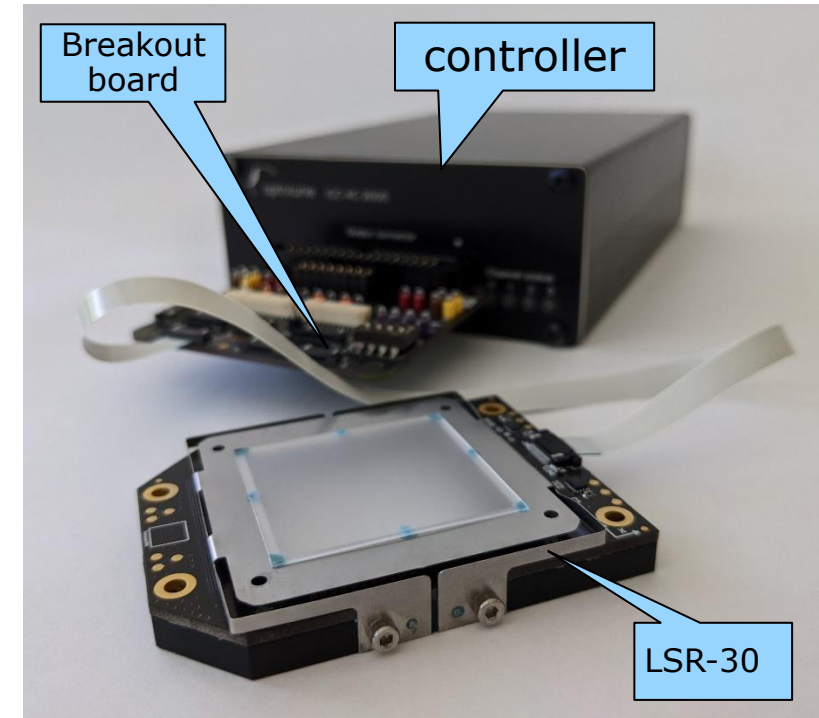
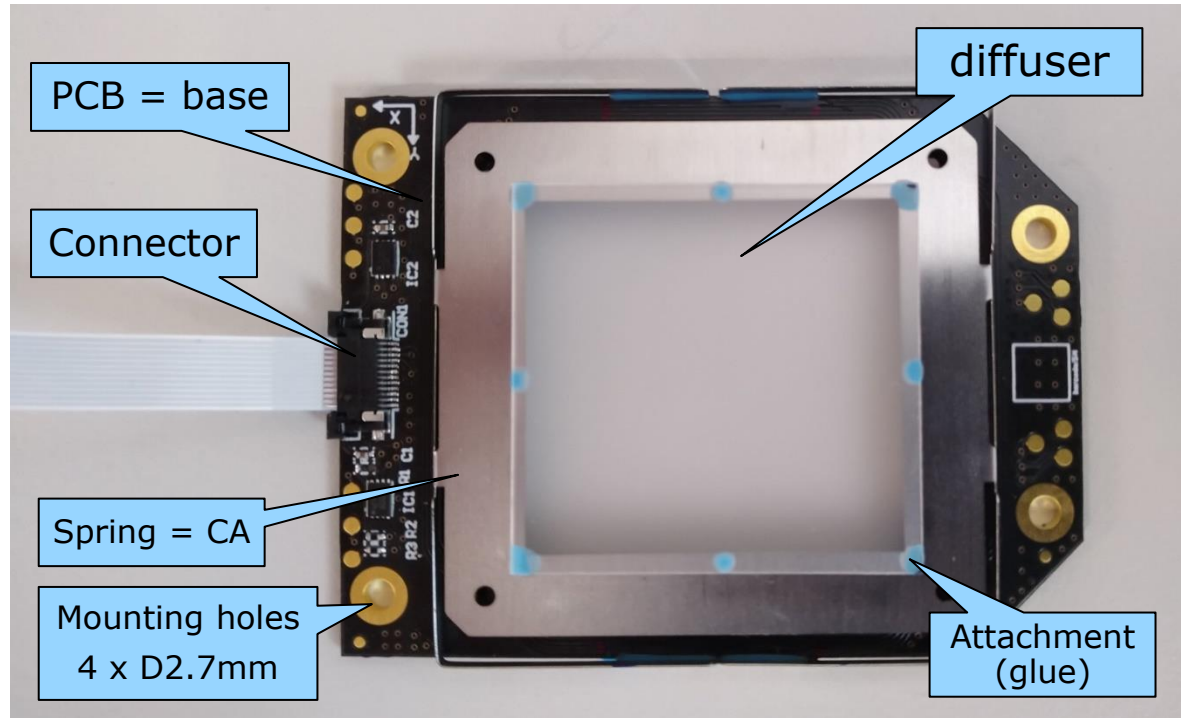

- What is included
 - LSR-30 engineering sample + PWM driver
 - Diffuser options: Polycarbonate, various angles
 - Characterization sheet indicating optimum operation parameters

LSR-30: Visual checked, it de-speckles well



Beam de-speckling at different excitation amplitudes

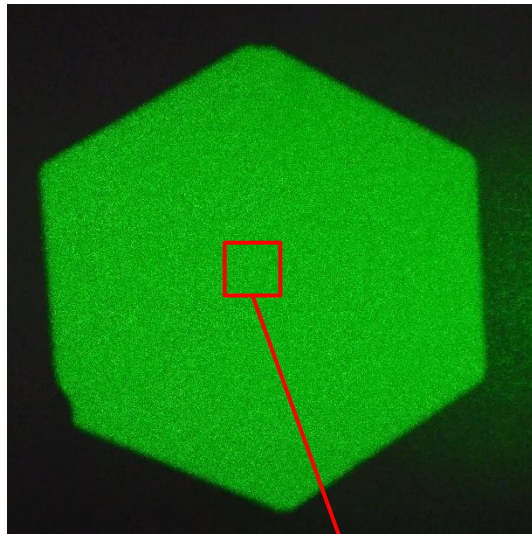

LSR off

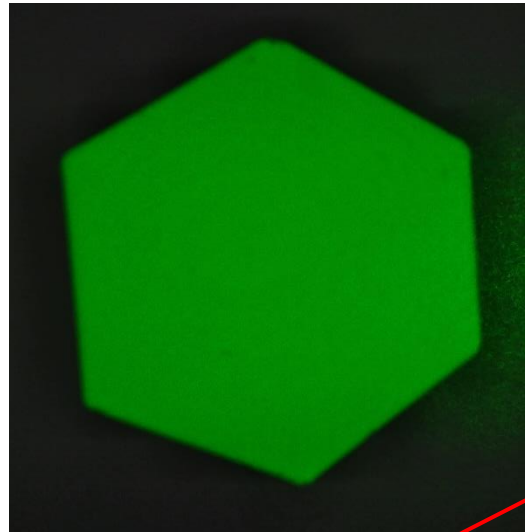

LSR at 74mA

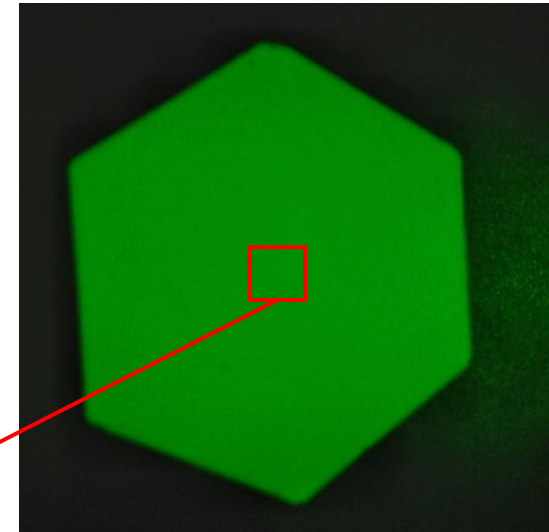

LSR at 213mA →
ca. 1.1mm orbit



Result:

- (visually checked) the objective speckles are reduced significantly

Agenda



- Intro
- Products
- Applications

Optotune provides a different solution for each laser-based HUD type



LSR in light path

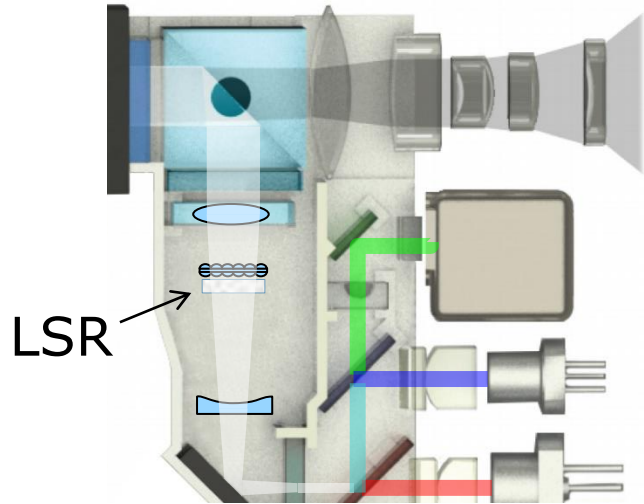

- 5x5mm aperture
- LSR placed before homogenizer
- Std products available



Standard LSR

LSR in image plane

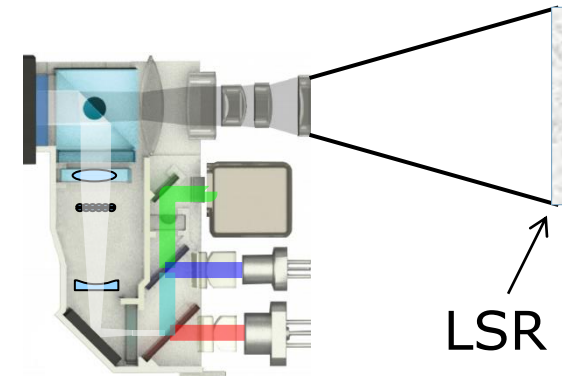

- 20x50mm aperture
- Best speckle reduction (no subjective speckles)
- Basic technology available (reluctance force), but customization required



Customized LSR

Example: Light engine for laser projector

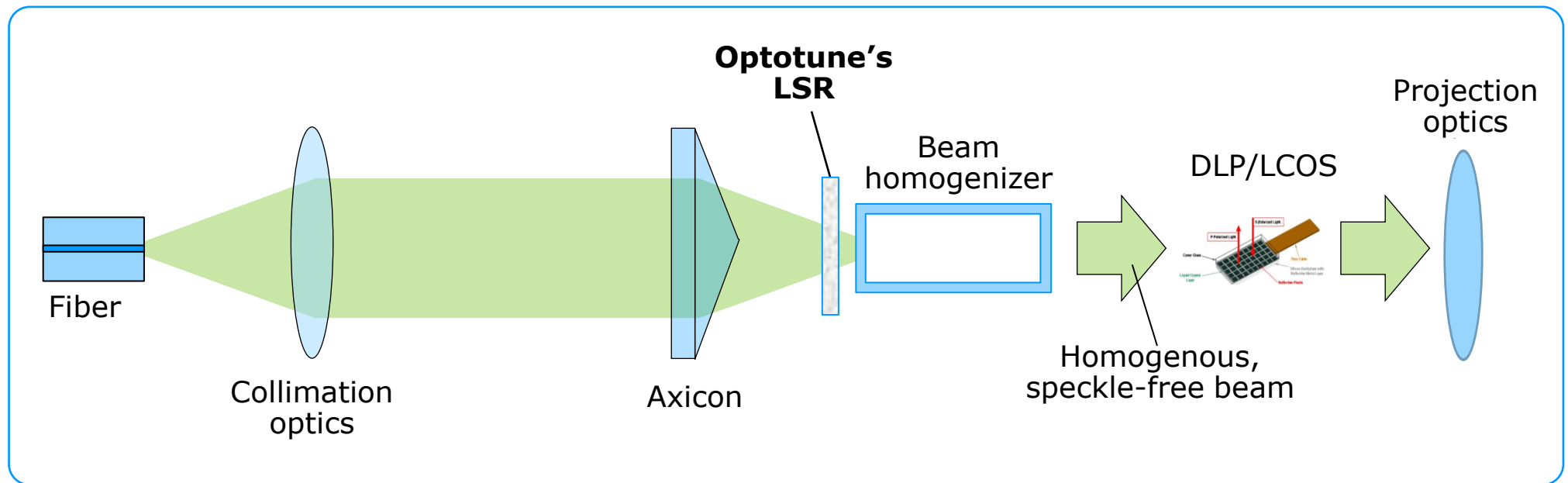

- Effective speckle reduction has been shown using
 - an axicon as a focusing lens
 - Optotune's LSR
 - directly followed by a beam homogenizer
- Such a setup is compact, cost-saving and easy to align

LSR in intermediary image plane of a HUD



How does a head-up display work?

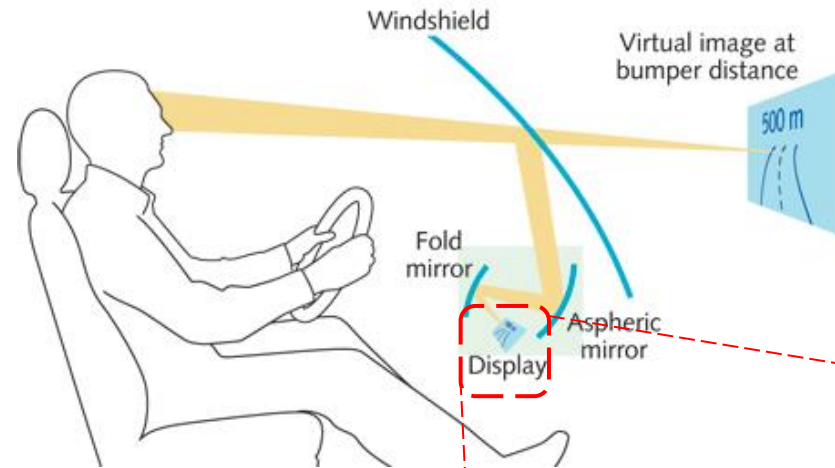

Place LSR in intermediate image plane ("shaking screen")

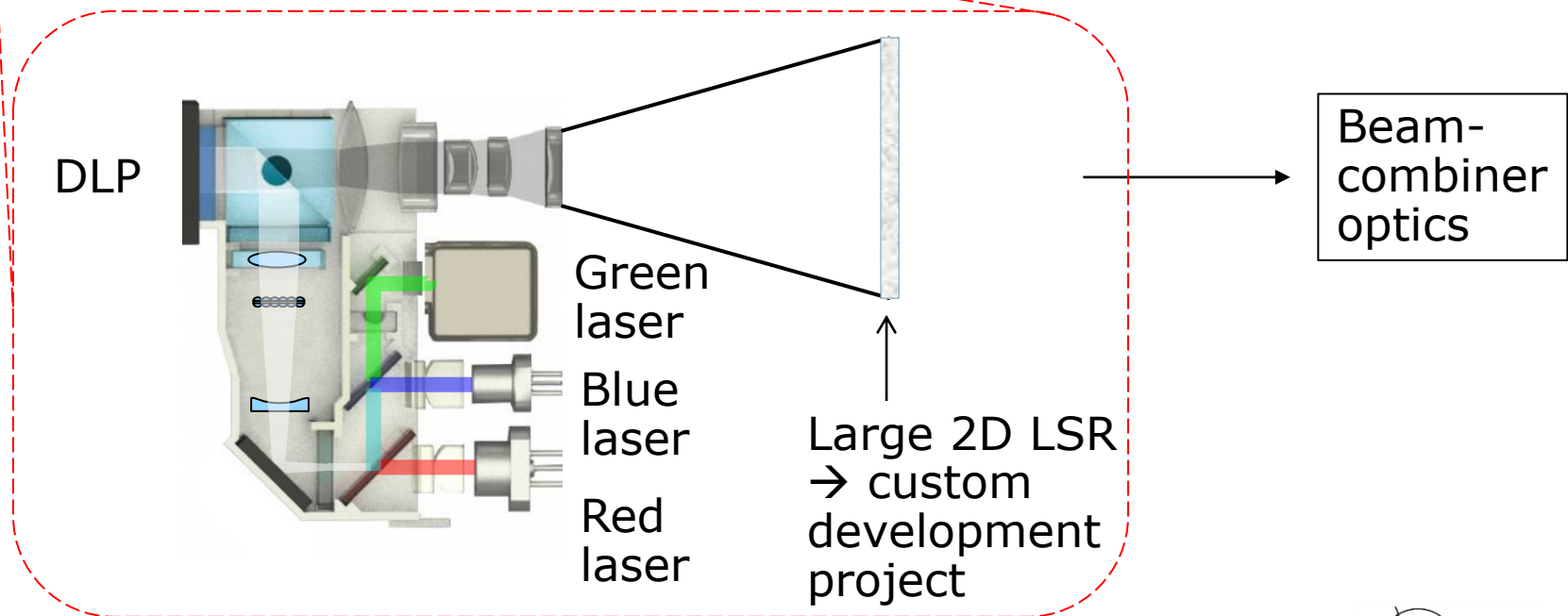

Fiber coupling: Best layout is to image a spot on the diffuser

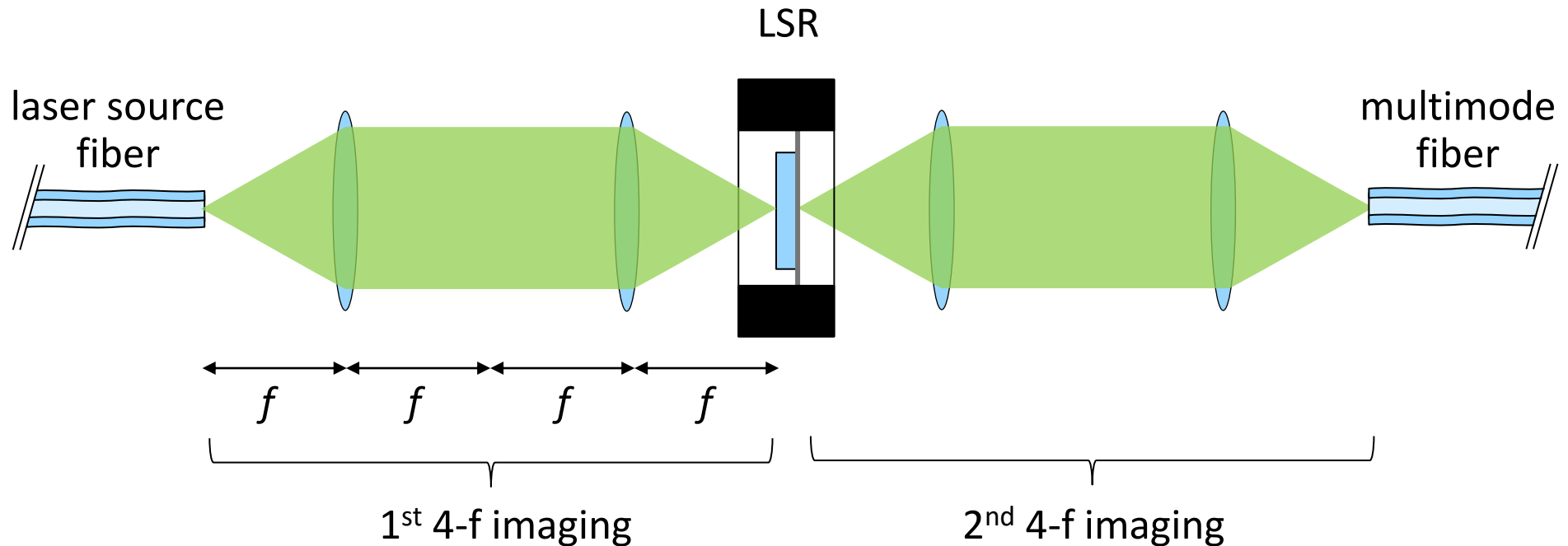

- Spot size on diffuser < diameter of fiber core
- No static diffuser allowed

Good speckle reduction shown with 75% efficiency



- Speckle reducer: LSR-5-17-17S-VIS with single 17° diffuser
- Fiber: 100 μ m core, 0.5 NA
- Off-the-shelf glass aspheres

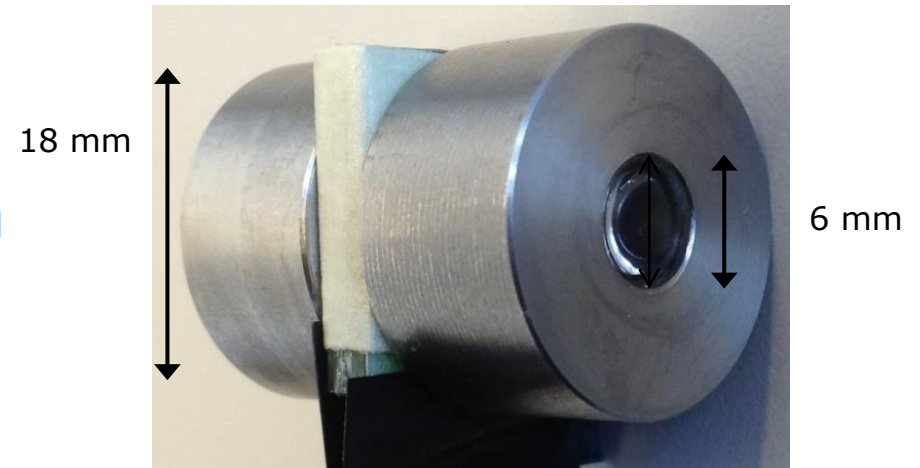
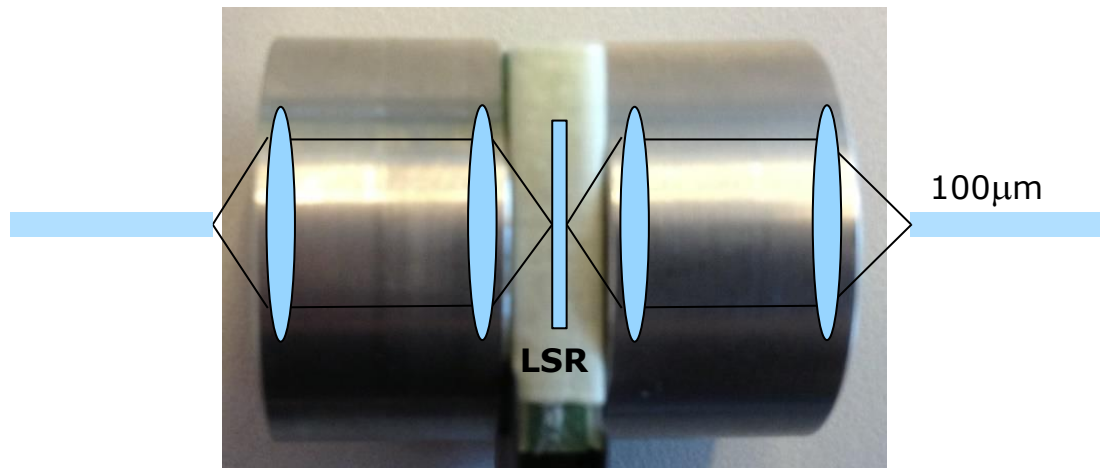

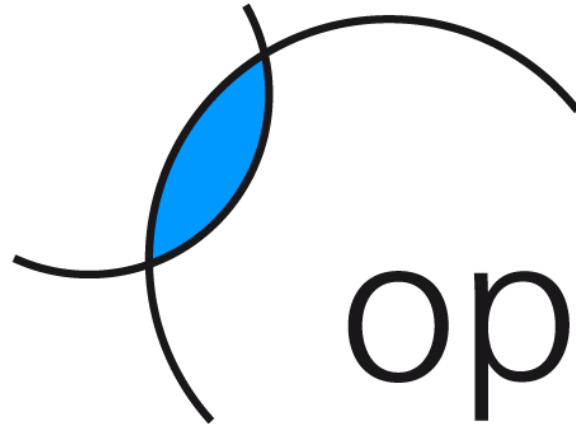

optotune

shaping the future of optics

Optotune Switzerland AG
Bernstrasse 388
CH-8953 Dietikon
Switzerland

Phone: +41 58 856 3000 | Fax: +41 58 856 3001
www.optotune.com | sales@optotune.com