

ECC-1C embedded lens controller

Optotune's ECC-1C allows to control liquid lenses directly from camera or embedded systems, thus offering a compact and convenient solution for fast integration.



Main features:

- Connects directly to cameras and embedded systems
- Current control from -300 to +300 mA in 80 μ A steps
- Communication interfaces:
 - UART and I2C (autodetect)
 - Analog input (0 - 10V)
 - GPIO trigger
- Read-out of calibration data & temperature for compensation ("Focal Power Mode")
- Graphic user interface *Optotune Cockpit* for control via UART, USB to UART cable available
- Software SDKs for Python and C# available
- RoHS, REACH and CE declaration of conformity

Mechanical specifications

Dimensions (L x W x H)	27 x 20 x 5	mm
Weight	5	g
Connector	Hirose HR10G-7R-6SB(73)	
Max. USB cable length extension ¹	5	m
Max. lens cable length (USB to UART) ²	1	m

Electrical specifications

Supply voltage range	5 / 9-24 (tolerance \pm 5%) Two input voltage ranges (no operating window in between)	VDC
Absolute maximum supply voltage	26	VDC
Nominal control current ³	-300 to 300	mA
Current step	80	μ A
Current repeatability	\pm 1	mA
Maximum power consumption (5V / 9-24V)	1.5 / 2.5	W
Analog voltage inputs level	0-10	V
Absolute maximum analog voltage input	11	V
Analog input resolution	12	Bits
Analog input impedance	>70	K Ω
Digital interfaces	GPIO, UART, I2C	
Digital signal logic level	3.3	V
UART Simple mode command latency ⁴	310	μ s
I2C command latency ⁵	max. 100	μ s

¹ Maximum tested cable length in lab conditions, actual performance may depend on electromagnetic environment. Longer lengths are possible using active USB cables.

² Maximum tested cable length in lab conditions. Maximum cable length may depend on electromagnetic environment. Higher cable lengths should comprehend lower baud rates.

³ Input voltages and thermal limitations apply, see Figure 4, 5, 6 and 7.

⁴ Average delay between end of command on UART RX line and output change using simple mode commands in Terminal app. Generally, the whole configuration time varies with command length, speed of communication and its mode, infrastructure, control host, operating system, programming language etc. This delay time variation also applies for protocol mode commands.

⁵ Analogically defined delay but using I2C communication bus. It corresponds also to latency of GPIO input trigger by both rising and falling edge.

Thermal specifications

Operating temperature	0 to 65	°C
Storage temperature	-40 to 85	°C

Ordering information

The ECC-1C can be part of Optotune’s EL-16-40 lenses or ELMs (electrical lens modules) or ordered separately. Currently two cable options are provided.

Part number	Description
150-347-00	Hirose adapter kit with ECC-1C
150-349-00	USB to UART cable, Hirose connector, 1m
152-219-00	CAB-6-100-M-OE (Hirose to open-ended wire cable, 1m)
149-740-01	EL-16-40-TC-VIS-5D-C-E (Typical EL-16-40 lens with ECC-1C integrated)

Mechanical layout

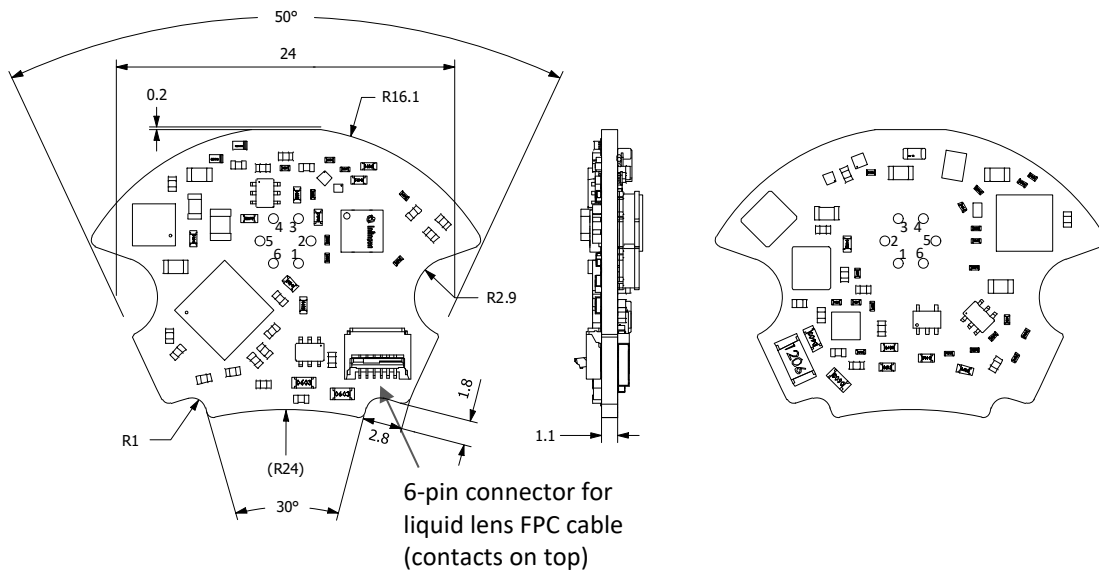

Figure 1: Mechanical drawing of ECC-1C PCB.

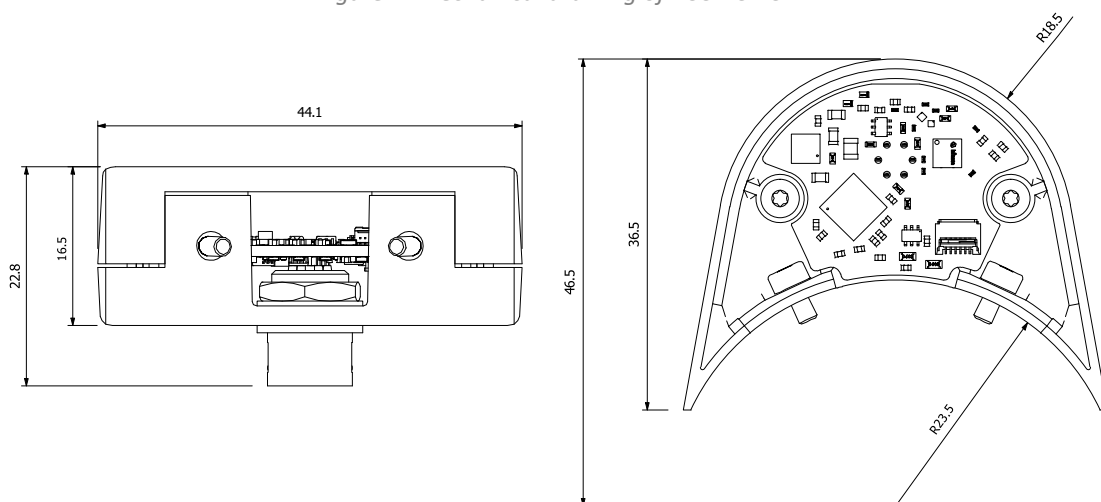

Figure 2: Mechanical drawing of ECC-1C adaptor.

Electrical connection

The electrical connection of the ECC-1C consists of Hirose a female Hirose connector (HR10G-7R-6SB) mounted on the thermoplastic controller housing:

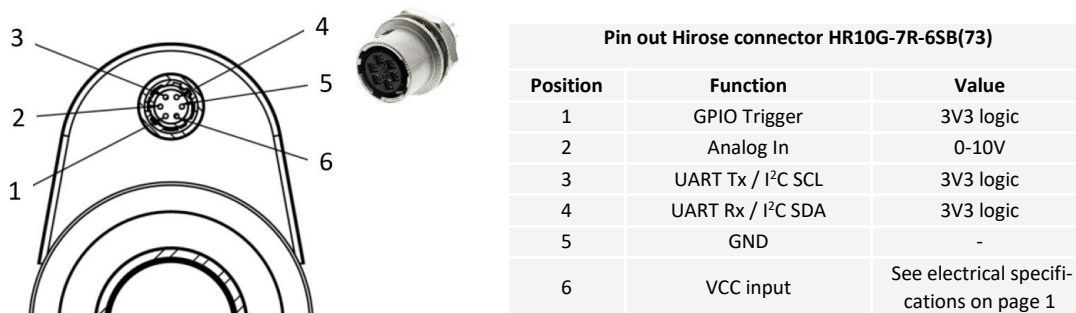

Figure 3: Electrical connections of ECC-1C featuring (female) Hirose connector.

6-pin flex cable connector is the connection between lens and ECC-1C controller. Controller provides current control for lens coil and internal I2C communication with lens' EEPROM and temperature sensor readout. **Lens flex cable pins must face upwards when connected.**



Figure 4: Electrical connections of flex cable connector.

Interface options

The ECC-1C is best controlled using the digital interfaces UART or I2C. The respective communication protocol is detected automatically. While both protocols offer a pro-mode with register-based command structure, the UART protocol offers also a simple mode based on ASCII text commands. Furthermore, it is also possible to pre-configure a look-up table, which allows for analog 0-10 V control, or vector-based waveforms, which can be triggered via the GPIO pin.

Available drive current vs. temperature

The guaranteed drive current available from ECC-1C depends on the lens type, voltage supply and ambient temperature as detailed in the graphs below (Figure 5, 6, 7 and 8).

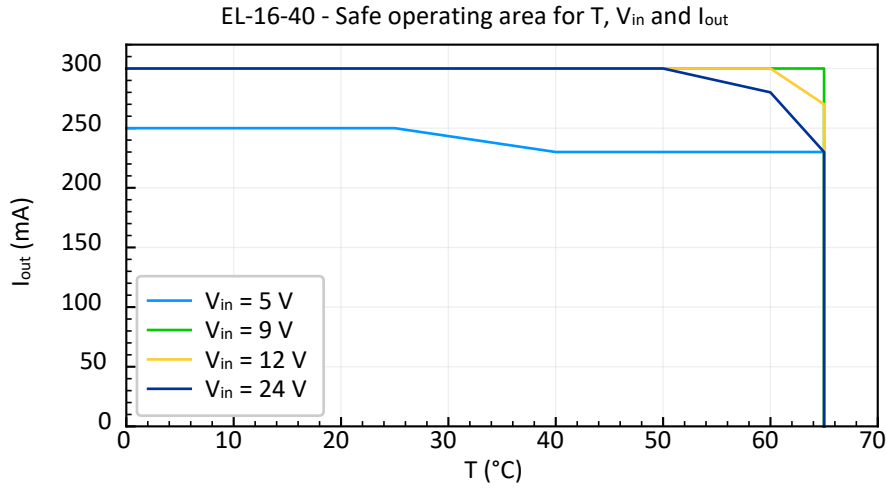

Figure 5: Guaranteed drive current for EL-16-40 lens available from ECC-1C.

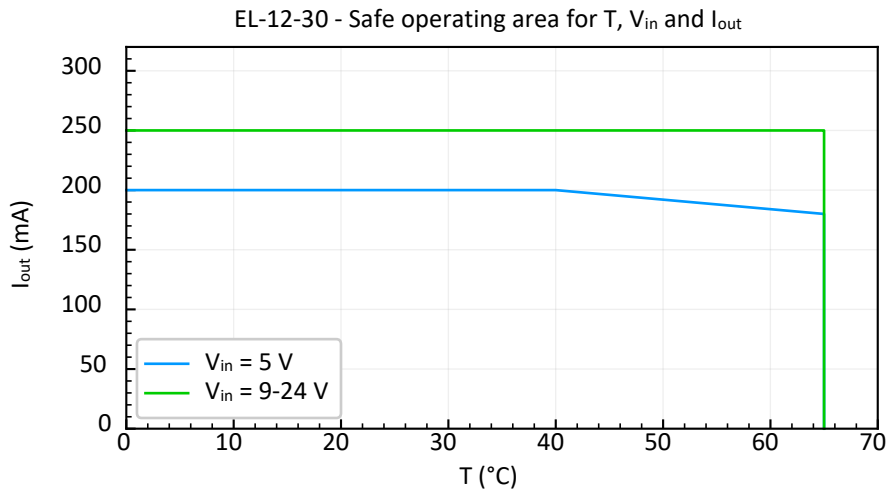

Figure 6: Guaranteed drive current for EL-12-30 lens available from ECC-1C.

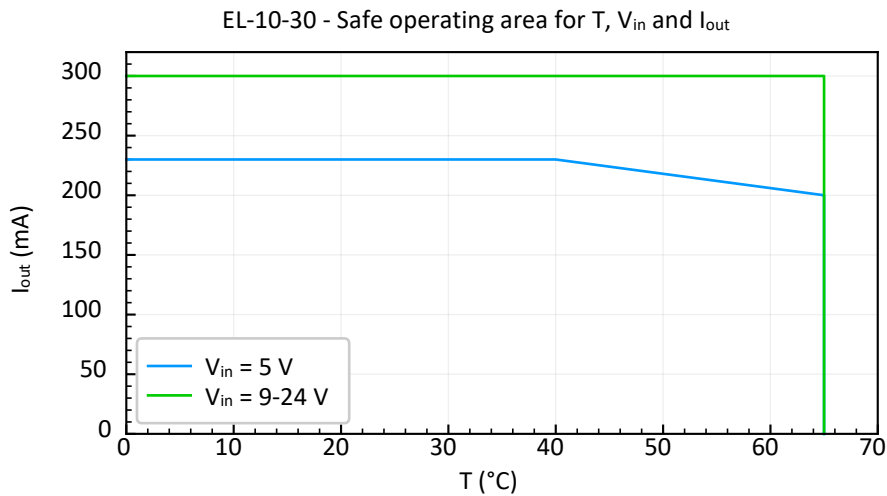

Figure 7: Guaranteed drive current for EL-10-30 lens available from ECC-1C.

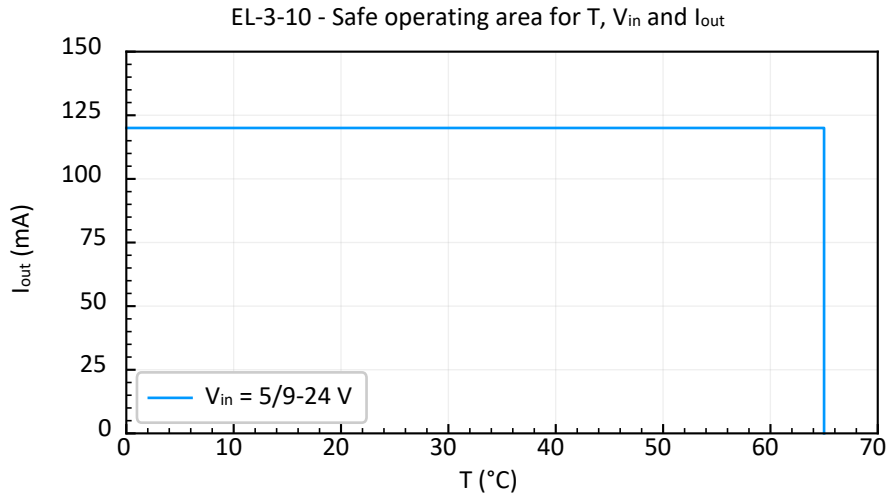
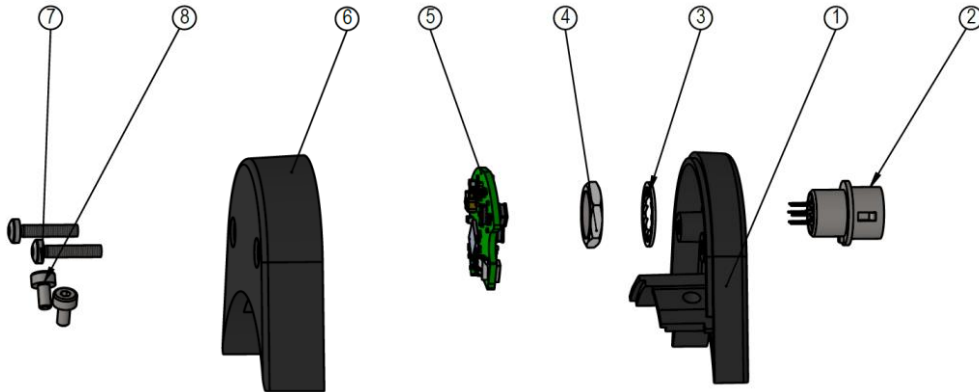

Figure 8: Guaranteed drive current for EL-3-10 lens available from ECC-1C.

ECC-1C adapter kit (P/N 150-347-00)

This adapter kit allows for addition of ECC-1C to EL-16-40-threaded lenses and many ELMs (electrical lens modules). The kit consists of:



Position	Quantity	Part number	Description
1	1	134-606-00	Housing bottom
2	1	132-281-01	HR10G-7R-6SB(73) connector
3	1	132-281-02	HR10G-7R-6P washer
4	1	132-281-03	HR10G-7R-6P nut
5	1	146-399-00	ECC-1C PCBA
6	1	134-607-00	Housing top
7	2	134-658-00	Screw, K20x10 BN20138
8	2	134-657-00	Screw, M2x4, DIN912 BN610

(Items 1-5 are provided pre-assembled, the rest in plastic zip bags)

Cable accessories

Optotune provides two cabling options for the ECC-1C:

- 150-349-00: USB to UART cable, Hirose connectors, 1m. Contains USB type-A integrated UART converter ([Silicon Labs CP2102](#))
- 152-219-00: CAB-6-100-M-OE - Hirose to open-ended wire cable, 1 m (Figure 8)

Pin	Cable Color	Function
1	Black/thin	GPIO trigger
2	Red/thin	Analog In
3	Grey/thin	Tx/SCL
4	Green/thin	Rx/SDA
5	Blue/thick	GND
6	Brown/thick	VCC

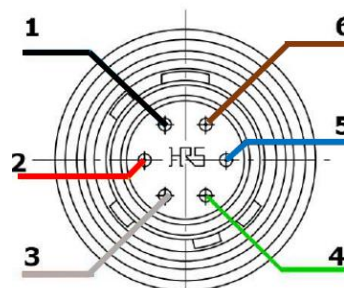

Figure 9: Pinout and color code of Hirose to open-ended wire cable.

Simple mode communication

Simple mode communication is RS-232 based serial communication interface that can be used to communicate to the device via a Serial Terminal (e.g., Terminate, Putty. Baud rate: arbitrary, Parity: N, Stop bits: 1, Data bits: 8). Baud rate autodetection feature is also well adapted to baud rate changes on the run. To correctly setup a new baud rate “start” command should be used. It employs a set of ASCII characters commands and answers to interact with ECC-1C. Commands and replies are terminated by character sequence CR, LF (resp. 0x0D, 0x0A). The protocol is not case sensitive and white spaces are ignored.

Simple mode command	Description
START[CR][LF]	Answers “OK” if controller is ready to use and device is detected. Otherwise “ERROR” is received.
STATUS[CR][LF]	Controller answers with status encoded within 4 Bytes information. Example: “0x00015000[CR][LF]”. See next section for further description of the status bytes.
ACKNOWLEDGE[CR][LF]	Clears history error flags in the status register. Answers “OK”.
RESET[CR][LF]	Restarts controller’s firmware. Note: no answer is sent via serial line
GOTODFU[CR][LF]	Starts controller’s loader for firmware update. Note: no answer is sent via serial line
GOPRO[CR][LF]	Starts binary protocol-based mode of serial communication. Serial message CRC is not checked.
GOPROCRC[CR][LF]	Starts binary protocol-based mode of serial communication. Serial message CRC is checked.
GETID[CR][LF]	Answers with firmware serial number. Example: “14352500-00-A[CR][LF]”.
GETVERSION[CR][LF]	Answers with firmware version number. Example: “1.0.740706[CR][LF]”.
GETGITSHA1	Answers with 40 bytes hexadecimal GIT build identification. Example : “eb8115e6b04814f0c37146bbe3dbc35f3e8992e0[CR][LF]”
GETSN[CR][LF]	Answers with board and device serial number. Example: “Board: CDAA0057, Device: ANAA1234[CR][LF]”.
DETECTDEVICE[CR][LF]	Runs autodetection of device on active channel, answers with device name. Example: “EL-16-40-TC[CR][LF]”.
GETDEVICESN[CR][LF]	Answers with serial number of a device connected. Example: “Device: ANAA1234[CR][LF]”
SETCURRENT=%float[CR][LF]	Sets current value. Command supports decimal parameter value in mA units. Current value is limited either by power capabilities of ECC-1C controller itself or connected device.
GETCURRENT[CR][LF]	Answers with value of active current. Returned value is decimal number in units of milliamperes, Example: “15.6[CR][LF]”
SETFP=%float[CR][LF]	Sets focal power. Supports float value in units of diopters limited to detected lens device capability.

GETFP[CR][LF]	Answers with focal power. Returned value is a float in diopters. If no lens is detected, it returns "NO".
GETFPMIN[CR][LF]	Answers with focal power lower limit of lens device connected. Returned focal power is decimal value in diopters. If no lens is detected, it returns "NO".
GETFPMAX[CR][LF]	Answers with focal power upper limit of lens device connected. Returned focal power is a decimal value in diopters. If no lens is detected, it returns "NO".
GETTEMP[CR][LF]	Answers with actual temperature of device connected. Returned temperature is a decimal value in units of degree Celsius. Example : "27.54[CR][LF]".
SETTEMLIM=%f[CR][LF]	Sets operational temperature limit in degree Celsius.

Simple mode reply	Description
OK[CR][LF]	Command accepted and performed without limits.
NO[CR][LF]	Command not accepted, for any reason.
OL[CR][LF]	Command not accepted, because parameter reached lower limit.
OU[CR][LF]	Command not accepted, because parameter reached upper limit.
ERROR[CR][LF]	Command not available.

Control via analog input

The ECC-1C can be controlled via a dedicated 0-10 V analog input. The resolution of the ADC is 12 bits. The analog input can be mapped to Current or Focal power (if applicable) of the connected lens. Both linear and non-linear mapping are possible.

For additional information on how to set up the analog mapping, please refer to the Optotune Cockpit software manual.

Waveforms with output or input trigger

The ECC-1C has a build in signal generator, which can be configured for different types of waveforms:

- Sine
- Rectangle
- Triangle
- Sawtooth
- Pulse
- Steps
- Any custom vector

By default, the controller outputs a trigger signal on the GPIO pin. The trigger signal is HIGH (3.3V, max. 5 mA) at phase 0° of the selected waveform and goes LOW in the middle of the period. For pulse pattern, it reflects the duty cycle.

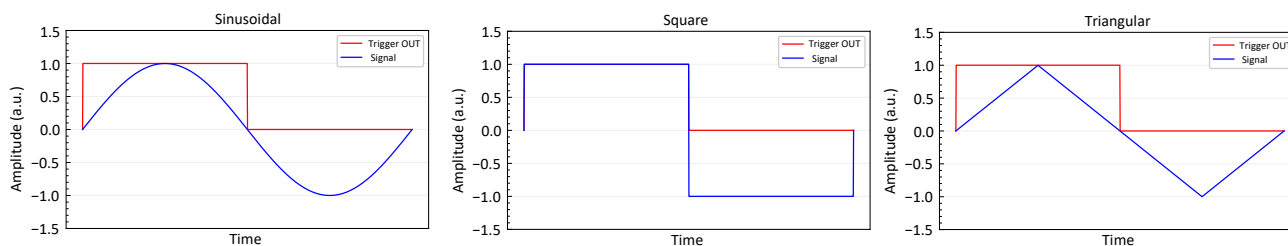

Figure 10: Different waveforms overlapped with the corresponding Trigger OUT signal.

The signal generator can also be synchronized with an external input trigger. When the trigger input signal goes HIGH (max 3.3V), the selected waveform starts off at phase 0°.

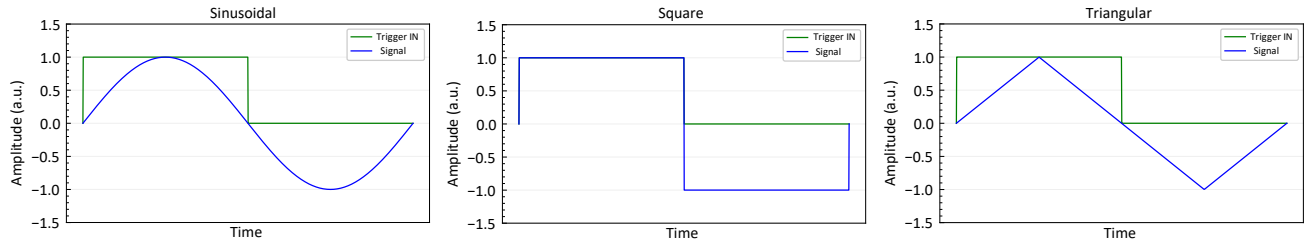

Figure 11: Different waveforms overlapped with an exemplary Trigger IN signal.

Safety and compliance

The product fulfills the RoHS, REACH and CE compliance standards. The customer is solely responsible for complying with all relevant safety regulations for integration and operation.

For more information on optical, mechanical, and electrical parameters, please contact sales@optotune.com

Supporting documentation (available on request)

The following support documentation is available on request:

- Firmware documentation and I2C/UART communication protocol
- ECC-1C Slave I2C communication protocol
- Installation guide for ECC-1C adapter kit