

Fine steering mirror FMR-20



Optotune's FMR devices have been designed with fine-tilt, high-angular resolution applications in mind. With a large clear aperture of 20 x 20 mm² they can scan various beam patterns at up to 250 Hz bandwidth with a ± 2.3 mrad tilt range. Together with the Optotune ICC-4C-2000 Industrial Current Controller, the FMR-20 is a plug-and-play fine steering solution.

Main features:

- One large optical surface for 2 DOF motion
- Linear (current vs angle)
- Bearingless design – no particles generated, no wear, no friction
- Suitable for high power laser applications¹

Tailoring to specific geometric, actuation, and optical requirements possible upon request.

Mechanical specifications

Actuator type	Voice coil	
Mechanical tilt angle, single axis ²	± 5.2 ± 0.3	mrad °
Mechanical tilt angle, simultaneous actuation of both axes ²	± 3.5 ± 0.2	mrad ° Circular field of view
Mirror size	20 x 20	mm
Mirror thickness	2	mm
Device dimensions (width x height x depth)	50.8 x 50.8 x 12	mm
Weight	53	g

Performance specifications

Motion pattern	2D programmable	
Position control	Open loop	
External sensor for feedback control	Can be added	
Scale drift	1000	ppm/K
Resolution (with ICC-4C-2000)	4	μ mrad
Static motor constant	17.5 1.0	mrad/A °/A
Dynamic motor constant	$1.2 \cdot 10^4$	rad/(As ²)
Resonance frequency	130 ± 5	Hz
Bandwidth (sine wave, ± 2.3 mrad)	250	Hz

¹ For high-power laser applications, a standard dielectric coating or a custom coating is required. It is the responsibility of the customer to provide a beam dump for the transmitted light and to ensure system-level laser safety.

² Higher mechanical tilt angles of up to $\pm 0.4^\circ$ can be reached, limited by mechanical tolerances. Please note that there is a risk of damaging the device at deflections larger than $\pm 0.3^\circ$, as well as increased noise and reduced overall performance. If you would like to operate the FMR-20 at such deflections, please contact sales@optotune.com.

Typ. transition (rise) time ³	1.3	ms
Settling time ³	4	ms

Optical specifications

Surface finish	Protected gold, dielectric NIR, custom	
Reflectivity		0-45° AOI
Protected gold	>95%, at 800-2000 nm	
Dielectric NIR	>98%, at 750-1100 nm	
Surface quality	5/ 5x0.4; L1x0.06; C3x0.25	ISO norm 10110, equivalent to scratch-dig 60/40
Mirror flatness	2 λ (1100 nm)	P-V

Electrical specifications

Max. continuous current (RMS)	single axis: 300 both axes: 200	mA, per channel
Max. peak current (10 ms duration)	1	A
Power consumption (average)	< 4	W
Nominal actuator resistance per channel	9.8	Ω
Temperature sensor	ILM75BTP,147 or compatible	I2C-address: 1001100x (R: 0x98 / W: 0x99)
EEPROM	M24C64-FMC6TG or compatible	I2X-address: 1010000x (R: 0xA0 / W: 0xA1)

Overview of available standard products

Standard Product	Version	Coating
FMR-20-PG-0.2x0.2D-M	Mounted in housing	Protected gold
FMR-20-DNIR-0.2x0.2D-M	Mounted in housing	Dielectric NIR
FMR-20-PG-0.2x0.2D	Unmounted	Protected gold
FMR-20-DNIR-0.2x0.2D	Unmounted	Dielectric NIR

Control

The FMR-20 is controlled with Optotune's ICC-4C-2000 industrial 4-channel controller, together with the ICC-4C-2000 extension kit (adapter board). One ICC-4C-2000 has four output channels and supports two FMR-20 devices. See separate datasheet for more information.

For the device control, please install the latest software and firmware from our [website](#):

- Optotune Cockpit (GUI)
- ICC-4C-2000 Firmware
- ICC-4C SDK in Python or C#

For optimized operation with arbitrary trajectories, a smart filter for the input signal is available in a function called SmartStep. For access to SmartStep, either within Optotune Cockpit or as part of the Python SDK, please contact sales@optotune.com.

³ The transition time is the time it takes from one setpoint to the next, within a 12.5% margin. The shortest transition times are reached with an optimized current input, available on the ICC-4C-2000. The settling time can be as small as three times the transition time. The transition time depends only moderately on the step size, here given for 3.5 mrad (half range).

Mechanical layout

The FMR-20 is offered in two configurations – mounted in a housing, and unmounted. The mechanical layout of the FMR-20 in a housing (product name FMR-20-PG-0.2x0.2D-M or FMR-20-DNIR-0.2x0.2D-M) is illustrated in Fig. 1. The housing supports mounting on standard optical posts (M4).

The mounted version of the FMR-20 facilitates plug-and-play operation of the device.

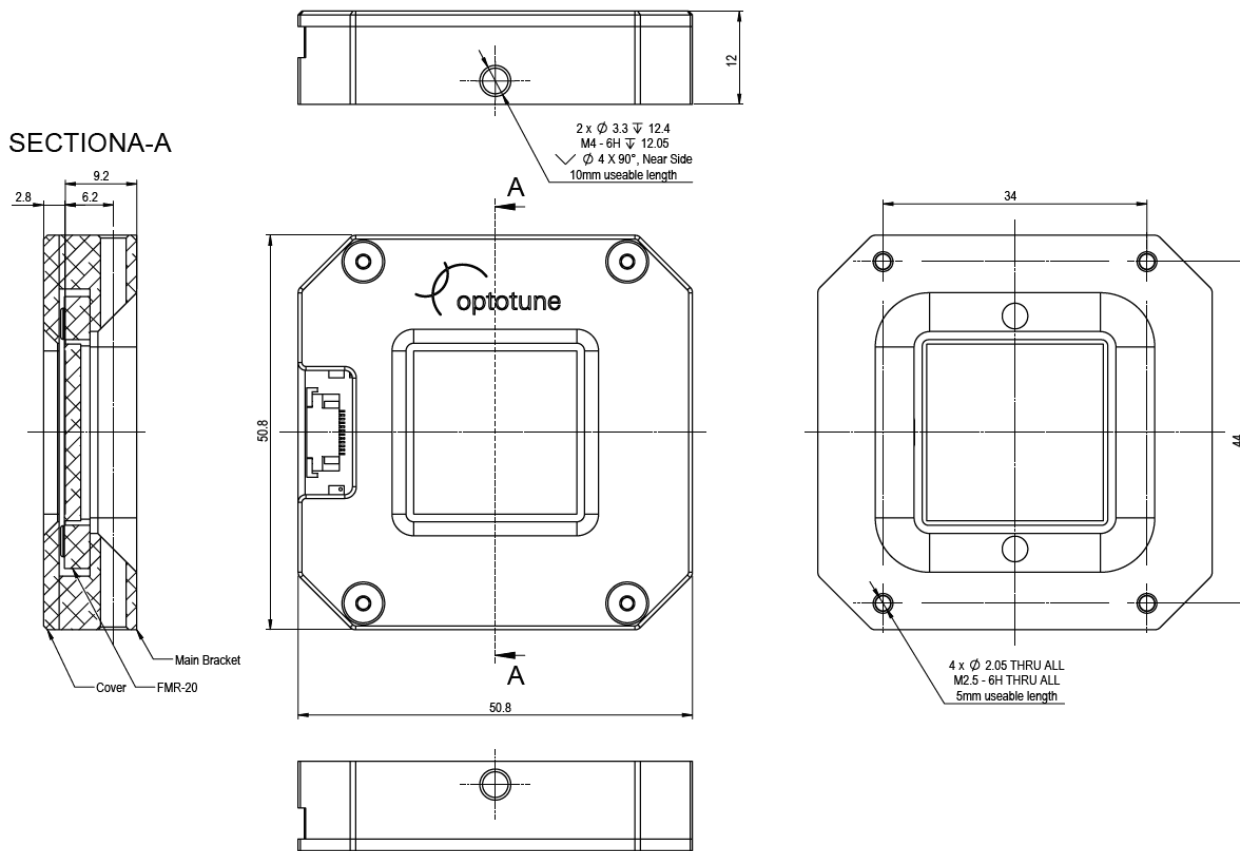

Figure 1: Mechanical drawing of the FMR-20 mounted in a housing. Units: mm.

The housing of the FMR-20 is compatible with the kinematic mount #58-861 from Edmund Optics (not included), shown in Fig. 2. This tip-tilt stage allows to do a manual angular coarse adjustment. The item is to be purchased directly from Edmund Optics.

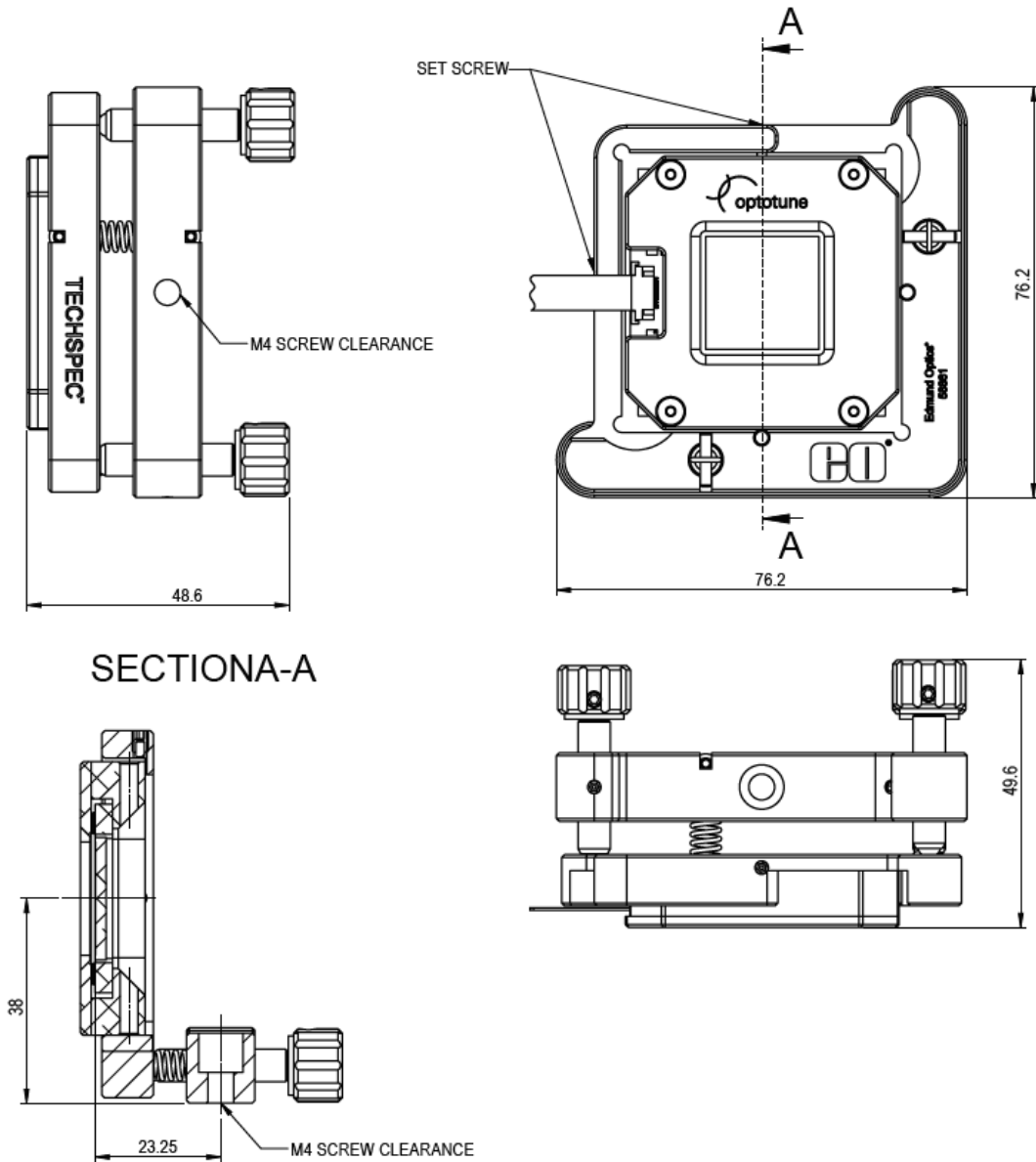

Figure 2: Compatible kinematic mount for the FMR-20.

The mechanical layout of the FMR-20 without the housing (product name FMR-20-PG-0.2x0.2D or FMR-20-DNIR-0.2x0.2D) is illustrated in Fig. 3. For more details on this configuration, please contact Optotune.

The unmounted version of the FMR-20 simplifies the integration of the device into other systems.

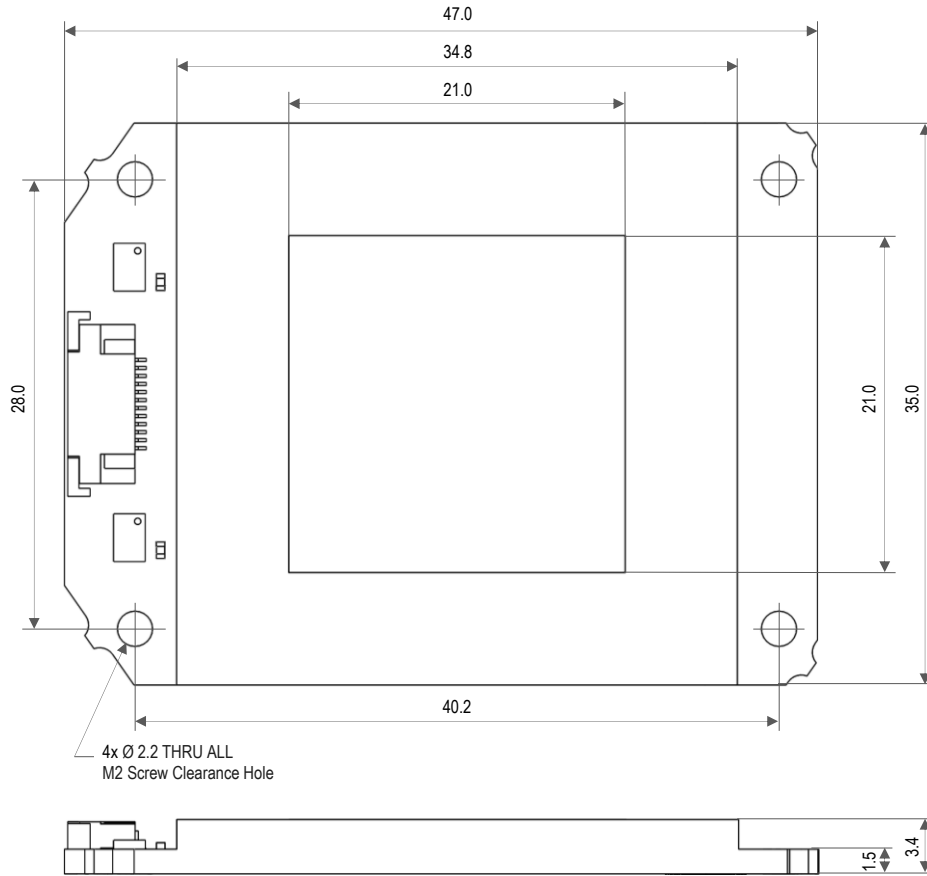

Figure 3: Mechanical drawing of the unmounted FMR-20. Units: mm.

Electrical layout

The FMR-20 connection is a standard FFC cable (Molex 12 pin, 0.5 mm pitch). The cable can be plugged directly into the connector of the adaptor board, following Fig. 4: open the connector clamp with tweezers, insert the flex cable fully with the copper pads facing upwards, and close the black clamp by pushing both sides simultaneously.

IMPORTANT: Do NOT hotplug the flex cable from the device!

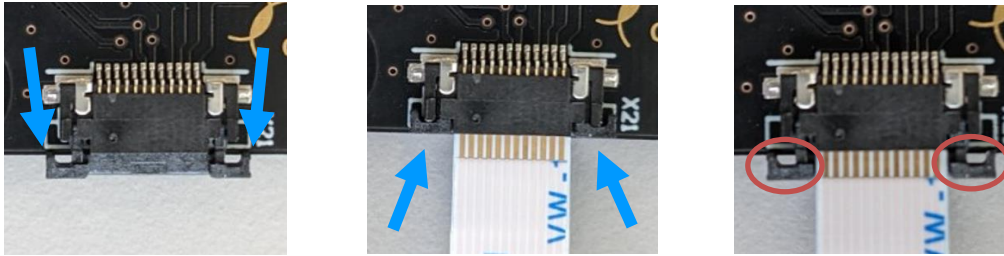
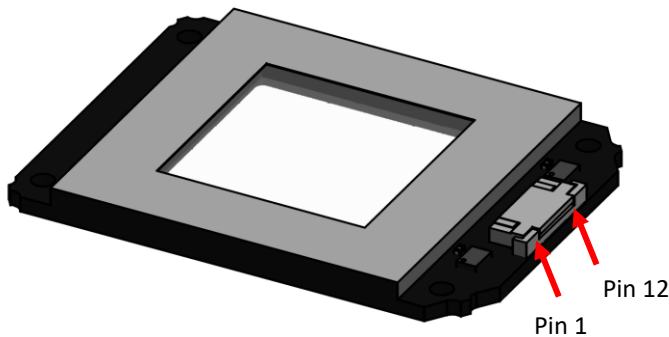

Figure 4: FFC cable connection. From left to right: open the connector clamp, indicated by blue arrows; insert the cable and close the connector clamp; connection cannot be guaranteed if the clamp is still open.

The pinout of the FMR-20 is shown in Fig. 5.



Pinout: FMR-20		
Position	Function	Value
1	Axis X+	0-300 mA
2	Axis X-	0-300 mA
3	Axis Y+	0-300 mA
4	Axis Y-	0-300 mA
5	Vcc	3.3 V
6	I ² C SDA	Digital signal
7	I ² C SCL	Digital signal
8	GND	-
9	N.C.	-
10	N.C.	-
11	N.C.	-
12	N.C.	-

Figure 5: Pin assignment of the FMR-20. RMS values are stated for the X/Y axis current control.

Reflectivity

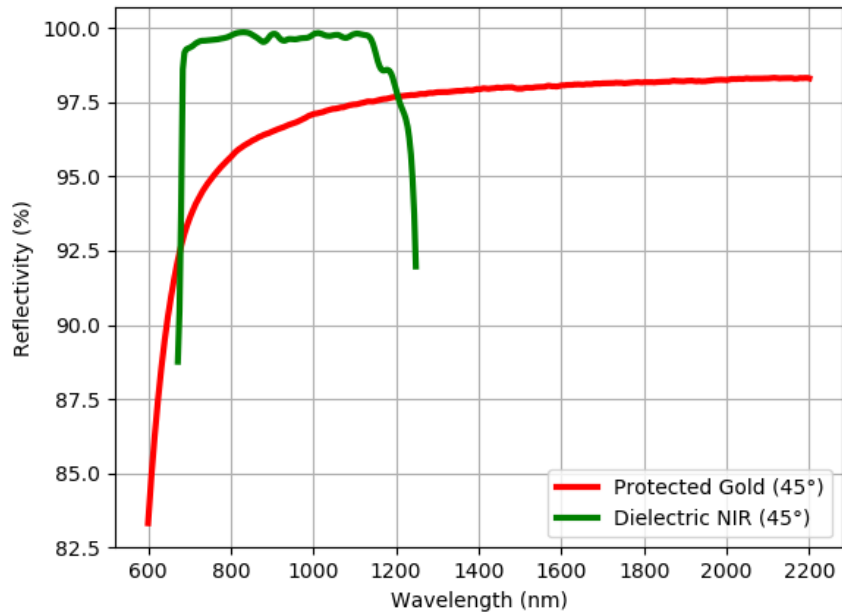

Figure 6: Reflectivity of the FMR-20 standard coatings.

Static response

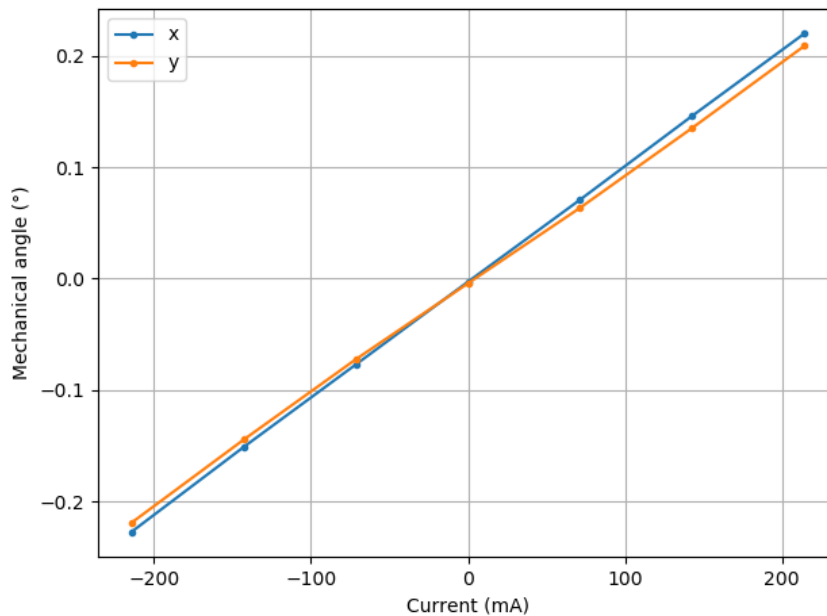

Figure 7: Typical static response as a function of current for the two axes of the FMR-20.

Frequency response

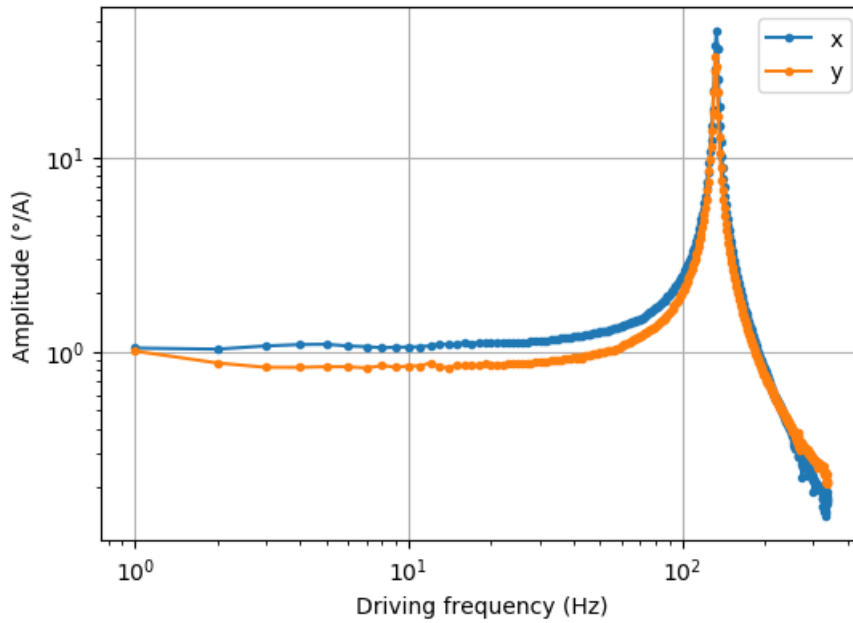

Figure 8: Typical frequency response for the two axes. The resonance frequencies for x and y are at 132 Hz and 133 Hz, respectively.

Step response

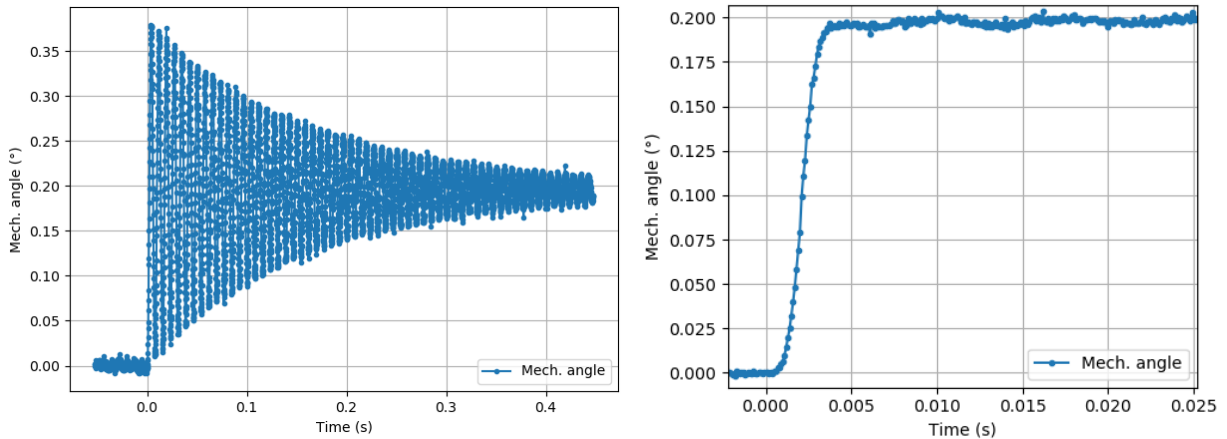

Figure 9: Step response of the FMR-20 with a sharp current step input (left) and optimized current input (right). Exciting the resonance can be avoided by filtering the input (available on the ICC-4C-2000 controller), which reduces the step response time from about 1 s to about 4 ms.

Safety and compliance

The product fulfills the RoHS, REACH, CE and UL94 V-0 compliance standards. The customer is solely responsible for complying with all relevant safety regulations for integration and operation.

For more information on optical, mechanical, and electrical parameters, please contact sales@optotune.com.